

F-tone Networks 40KM SFP+ ER Optical Transceiver

- ◆ Compliant with SFF-8431 and IEE802.3ae
- ◆ Supports rate up to 10.3 Gb/s bit rates
- ◆ 1G/2G/4G/ 8G/10G Fiber Channel applications.
- ◆ Data rate selectable $\leq 4.25\text{Gbps}$ or 9.95Gbps to 10.3Gbps bit rates
- ◆ Cooled EML transmitter and PIN receiver
- ◆ link length up to 40km
- ◆ Low Power Dissipation 1.5W Maximum
- ◆ Single 3.3V power supply
- ◆ Diagnostic Performance Monitoring of module temperature, supply Voltages, laser bias current, transmit optical power, receive optical power
- ◆ For the OBSAI application, the rates are 6.144Gb/s, 3.072 Gb/s, 1.536 Gb/s and 0.768 Gb/s.
- ◆ For the CPRI application, the rates are 6.144Gb/s, 3.072 Gb/s, 2.4576 Gb/s, 1.2288 Gb/s, 0.6144 Gb/s.
- ◆ RoHS compliant and lead free 
- ◆ Operating case temperature:
 - Standard : 0 to +70°C
 - Industrial : -40 to +85°C

- ◆ 10GBASE-ER/EW (with/without FEC)
- ◆ 10G Fiber Channel (with/without FEC)
- ◆ For the OBSAI application, the rates are 6.144Gb/s, 3.072 Gb/s, 1.536 Gb/s and 0.768 Gb/s.
- ◆ For the CPRI application, the rates are 6.144Gb/s, 3.072 Gb/s, 2.4576 Gb/s, 1.2288 Gb/s, 0.6144 Gb/s.
- ◆ 1G/2G/4G/ 8G/10G Fiber Channel applications.



F-tone Networks SFP+ER Transceiver is designed for 10GBASE-ER/EW, and 8.5G/10G Fiber-Channel applications.

The transceiver consists of two sections: The transmitter section incorporates a colded EML laser. And the receiver section consists of a PIN photodiode integrated with a TIA. All modules satisfy class I laser safety requirements. F-tone Networks SFP+ER Digital diagnostics functions are available via a 2-wire serial interface, as specified in SFF-8472, which allows real-time access to device operating parameters such as transceiver temperature, laser bias current, transmitted optical power, received optical power and transceiver supply voltage.

Supply Voltage	Vcc	-0.5	3.8	V
Storage Temperature	Tst	-40	85	°C
Relative Humidity	Rh	0	85	%

Supply Voltage	Vcc	3.13	3.3	3.47	V
Supply current	Icc		360	450	mA
Operating Case temperature	Tca	-5	-	70	°C
Module Power Dissipation	Pm	-	1.2	1.5	W

[1] Supply current is shared between VCCTX and VCCR_X.

[2] In-rush is defined as current level above steady state current requirements.

Center Wavelength		1530		1565	nm
Optical Average Power	Po	0	-	+3	dBm
Optical OMA Power	Pom	-2.1			dBm
Side Mode Suppression Ratio	SMSR	30	-	-	dB
Optical Transmit Power (disabled)	PTX_DISABLE	-	-	-30	dBm
Extinction Ratio	ER	8.2		-	dB
RIN _{21OMA} [1]				-128	dB/Hz
Optical Return Loss Tolerance				21	dB

[1] RIN measurement is made with a return loss at 21 dB.

Data Rate	Mra	-	10.3	11.3	Gbps



Input differential impedance	Rim	-	100	-	Ω
Differential data Input	VtxDIFF	120	-	850	mV
Transmit Disable Voltage	VD	2.0	-	Vcc3+0.3	V
Transmit Enable Voltage	Ven	0	-	+0.8	V
Transmit Disable Assert Time	Vn	-	-	100	us

Input Operating Wavelength		1530	-	1565	nm
Average receive power		-	-	-1.0	dBm
Receiver sensitivity in OMA		-	-	-14.1	dBm
Stressed receiver sensitivity in OMA[1]				-11.3	dBm
Maximum Input Power	RX-overload	-	-	-1	dBm
Reflectance	Rrx	-	-	-27	dB
Loss of Signal Asserted		-25	-	-	dBm
LOS De-Asserted		-	-	-16	dBm
LOS Hysteresis		0.5	-	-	dB

[1] Measured with conformance test signal for BER = 10⁻¹². The stressed sensitivity values in the table are for system level BER measurements which include the effects of CDR circuits. It is recommended that at least 0.4 dB additional margin be allocated if component level measurements are made without the effects of CDR circuits.

Data Rate	Mra	-	10.3	11.3	Gbps
Differential Output Swing	Vout P-P	350	-	850	mV
Rise/Fall Time	Tr / Tf	24	-	-	ps
Loss of Signal –Asserted	VOH	2	-	Vcc3+0.3-	V
Loss of Signal –Negated	VOL	0	-	+0.4	V

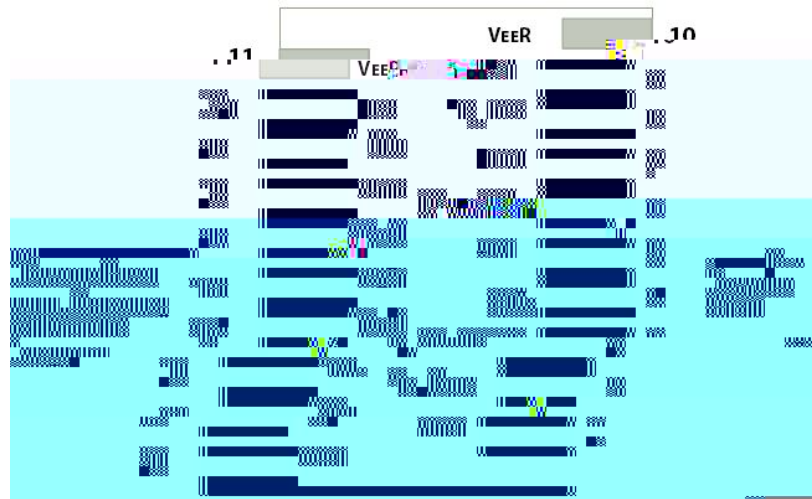

1	VEET [1]	Transmitter Ground
2	Tx_FAULT [2]	Transmitter Fault
3	Tx_DIS [3]	Transmitter Disable. Laser output disabled on high or open
4	SDA [2]	2-wire Serial Interface Data Line
5	SCL [2]	2-wire Serial Interface Clock Line
6	MOD_ABS [4]	Module Absent. Grounded within the module
7	RS0 [5]	RS0 for Rate Select: Open or Low = Module supports ≤ 4.25 Gbps High = Module supports 9.95 Gb/s to 10.3125 Gb/s
8	RX_LOS [2]	Loss of Signal indication. Logic 0 indicates normal operation
9	RS1 [5]	No connection required
10	VEER [1]	



18	TD+	Transmitter DATA in. AC Coupled
19	TD-	Transmitter Inverted DATA in. AC Coupled
20	VEET [1]	Transmitter Ground

[1] Module circuit ground is isolated from module chassis ground within the module.

[2].should be pulled up with 4.7k – 10k ohms on host board to a voltage between 3.15V and 3.6V.

[3]Tx_Disable is an input contact with a 4.7 k to 10 k pullup to VccT inside the module.

[4]Mod_ABS is connected to VeeT or VeeR in the SFP+ module. The host may pull this contact up to Vcc_Host with a resistor in the range 4.7 k to 10 k .Mod_ABS is asserted “High” when the SFP+ module is physically absent from a host slot.

[5] RS0 and RS1 are module inputs and are

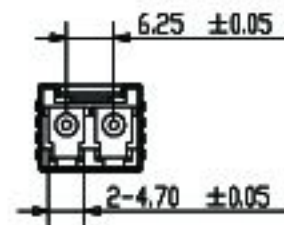
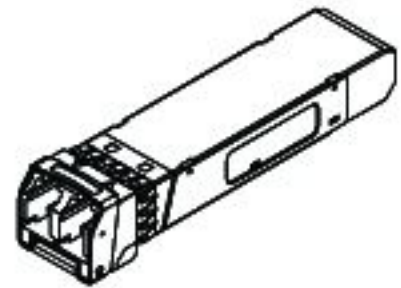
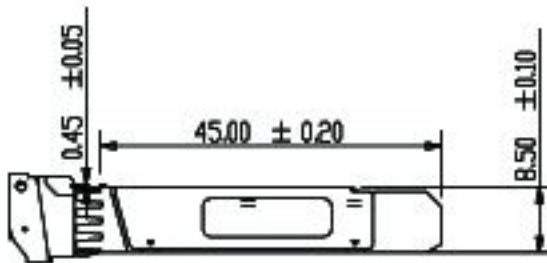
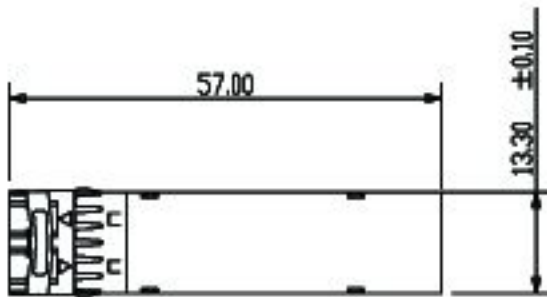
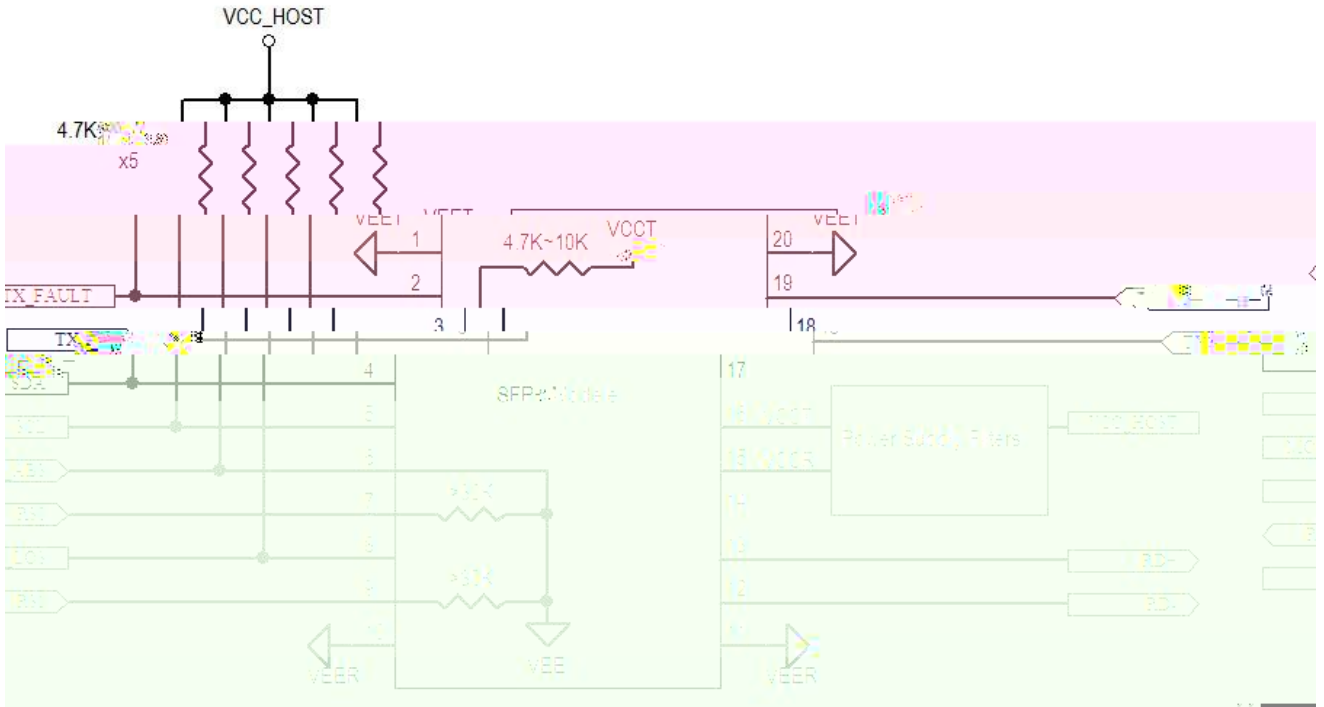



F-tone Networks SFP+ transceiver is designed to be Class I
